

2 Flute

Centre cutting high performance 2 flute rougher for graphite



END MILLS

N5-N7

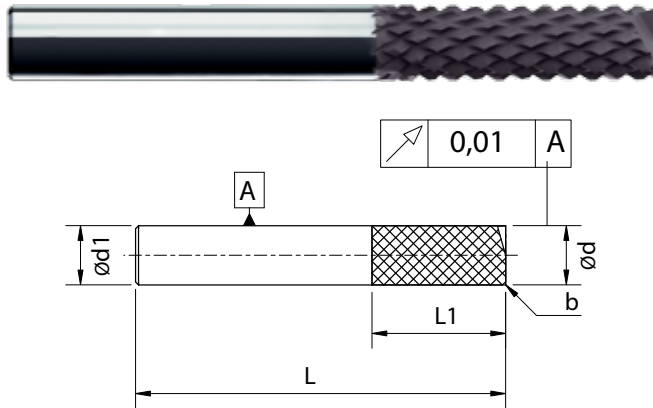

Unit : mm

Ød (mm)	b (mm)	Ød1 (mm)	L (mm)	L1 (mm)	L2 (mm)	a (mm)	z	γ (°)	EDP No
Standard									
4	0.25	4	60	12	-	-	2	-	FBK0504668
6	0.3	6	78	18	-	-	2	-	FBK0504669
8	0.35	8	78	24	-	-	2	-	FBK0504670
10	0.4	10	78	30	-	-	2	-	FBK0504671
12	0.5	12	89	36	-	-	2	-	FBK0504672
12	0.5	12	150	36	50	0.3	2	-	FBK0504673
16	0.5	16	150	36	70	0.4	2	-	FBK0504674

Unit : mm

Tolerance chart

Diameter range	Shank Ød1-h5	Cutting diameter Ød-e8	Cutting diameter Ød-f7	Cutting diameter Ød-g7	Cutting diameter ØFHC
d ≤ 3	0	-0.014	-0.006	-0.002	0
	-0.004	-0.028	-0.016	-0.012	-0.025
3 < d ≤ 6	0	-0.020	-0.010	-0.004	0
	-0.005	-0.038	-0.022	-0.016	-0.030
6 < d ≤ 10	0	-0.025	-0.013	-0.005	0
	-0.006	-0.047	-0.028	-0.02	-0.036
10 < d ≤ 18	0	-0.032	-0.016	-0.006	0
	-0.008	-0.059	-0.034	-0.024	-0.043
18 < d ≤ 30	0	-0.040	-0.020	-0.006	0
	-0.009	-0.073	-0.041	-0.024	-0.052



Solid Carbide End Mills

Cutting conditions

Centre cutting high performance 2 flute rougher for graphite

Material group	TSR	Hardness	Cutting speed	Coolant
	(N/mm ²)	HRc	Vc m/min	
N5			< 600	air
N6			< 600	air
N7			350 - 500	air

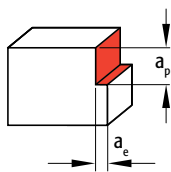

a_p up to $2.50 \times d$
 a_e up to $0.50 \times d$

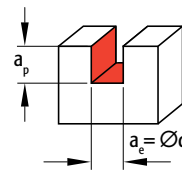

a_p up to $1.00 \times d$

Shoulder milling

Ød (mm)	ap max. (mm)	ae max. (mm)	fz (mm/tooth)
4	< 10.0	< 2.0	< 5000
6	< 15.0	< 3.0	< 6000
8	< 20.0	< 4.0	< 8000
10	< 25.0	< 5.0	< 10000
12	< 30.0	< 6.0	< 12000
16	< 35.0	< 8.0	< 15000

Slot milling

Ød (mm)	ap max. (mm)	ae max. (mm)	fz (mm/tooth)
4	< 4.0	4	< 3750
6	< 6.0	6	< 4500
8	< 8.0	8	< 6000
10	< 10.0	10	< 7500
12	< 12.0	12	< 9000
16	< 16.0	16	< 11250

FBK0504671

Workpiece material: EDM200 Graphite

	Totem
Ø	10mm
Z	2 Flutes
vc	628 m/min
n	20000 rpm
Fz	0.15 mm/t
vf	6000 mm/min
ap	12 mm
ae	2 mm
Coolant	air

Q	144 cm ³ /min
---	--------------------------

Higher productivity

To be used for roughing applications on graphite:

Advantages

- High material removal rate.
- Special roughing pitch.
- Designed for high feeds on graphite applications.



3 Flute

Centre cutting high performance 3 flute end mill for graphite



END MILLS



N5-N7

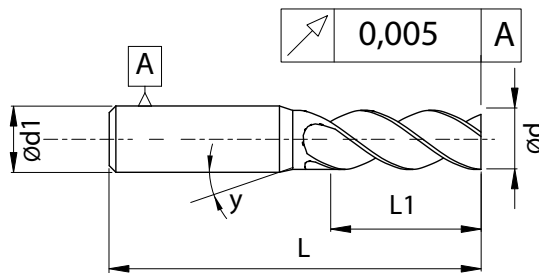

Unit : mm

Ød (mm)	r (mm)	Ød1 (mm)	L (mm)	L1 (mm)	L2 (mm)	a (mm)	γ (°)	EDP No
Standard								
2	-	3	50	10	-	-	15	FBK0503940
3	-	3	50	10	-	-	-	FBK0503941
4	-	4	60	15	-	-	-	FBK0503942
5	-	5	60	20	-	-	-	FBK0503943
6	-	6	78	30	-	-	-	FBK0503944
8	-	8	78	30	-	-	-	FBK0503945
10	-	10	78	30	-	-	-	FBK0503946
12	-	12	89	30	-	-	-	FBK0503947



Optimum
Flutes

Centre cutting high performance end
mill with corner radius for graphite



END MILLS

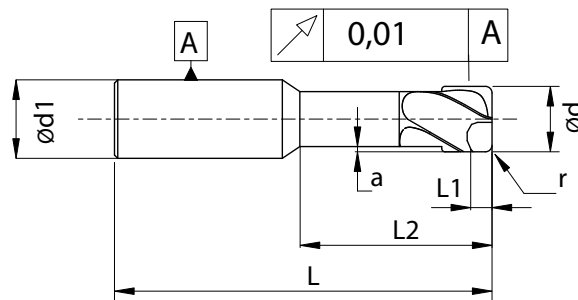

N5-N7

Unit : mm

Ød (mm)	r (mm)	Ød1 (mm)	L (mm)	L1 (mm)	L2 (mm)	a (mm)	z	γ (°)	EDP No
Short									
2	0.1	3	50	3	10	0.1	2	15	FBK0504675
3	0.1	6	51	4	10	0.1	2	15	FBK0504676
4	0.2	6	51	4	10	0.1	4	15	FBK0504677
5	0.2	6	51	5	10	0.15	4	15	FBK0504678
6	0.3	6	51	6	10	0.2	4	-	FBK0504679
8	0.3	8	64	8	15	0.3	4	-	FBK0504680
10	0.3	10	78	10	20	0.3	4	-	FBK0504681
12	0.3	12	78	10	20	0.3	4	-	FBK0504682
Standard									
2	0.1	2	50	10	-	-	3	-	FBK0504683
2	0.1	3	50	10	-	-	3	15	FBK0504684
2	0.1	3	50	10	15	0.1	3	10	FBK0504685
2	0.1	3	50	10	20	0.1	3	15	FBK0506035
2	0.1	3	65	10	30	0.1	3	15	FBK0504686
2	0.1	3	80	10	30	0.1	3	15	FBK0504687
3	0.1	3	50	10	-	-	3	-	FBK0504688

Optimum
Flutes

Centre cutting high performance end mill with corner radius for graphite



END MILLS

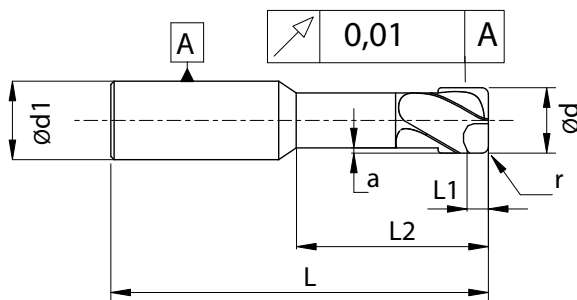

N5-N7

Unit : mm

Ød	r	Ød1	L	L1	L2	a	z	γ	EDP No
(mm)	(mm)	(mm)	(mm)	(mm)	(mm)	(mm)		(°)	
3	0.1	3	65	10	20	0.1	3	-	FBK0506036
3	0.1	3	65	10	30	0.1	3	-	FBK0504689
3	0.1	3	80	10	30	0.1	3	-	FBK0504690
4	0.2	4	60	15	-	-	3	-	FBK0504691
5	0.2	5	60	20	-	-	3	-	FBK0504692
6	0.3	6	78	30	-	-	3	-	FBK0504693
8	0.3	8	78	30	-	-	3	-	FBK0504694
10	0.3	10	78	30	-	-	3	-	FBK0504695
12	0.3	12	89	30	-	-	3	-	FBK0504696
Long									
4	0.3	4	102	10	-	-	2	-	FBK0504697
5	0.5	5	102	13	-	-	2	-	FBK0504698
6	0.5	6	102	42	-	-	2	-	FBK0504699
6	0.5	6	150	26	-	-	2	-	FBK0504700
8	0.5	8	150	41	-	-	2	-	FBK0504701
10	0.5	10	150	42	-	-	2	-	FBK0504702



Solid Carbide End Mills

Cutting conditions

- Center cutting high performance 3 flute end mill for graphite
- Center cutting high performance end mill with corner radius for graphite

Material group	TSR	Hardness	Cutting speed	Coolant
	(N/mm ²)	HRC	Vc m/min	
N5			< 600	air
N6			< 600	air
N7			350 - 500	air

Advantages

- More accuracy
- Smooth surface on the workpiece
- Better tool life

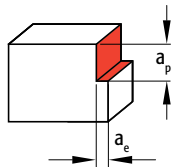

a_p up to $2.50 \times d$
 a_e up to $0.50 \times d$

Shoulder milling

Ød (mm)	ap max. (mm)	ae max. (mm)	fz (mm/tooth)
2	< 4.0	< 0.4	0.012 - 0.036
3	< 6.0	< 0.6	0.018 - 0.048
4	< 8.0	< 0.8	0.030 - 0.060
5	< 10.0	< 1.0	0.042 - 0.072
6	< 12.0	< 1.2	0.054 - 0.096
8	< 16.0	< 1.6	0.066 - 0.120
10	< 20.0	< 2.0	0.090 - 0.144
12	< 24.0	< 2.4	0.108 - 0.168

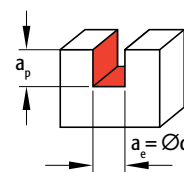

a_p up to $1.00 \times d$

Slot milling

Ød (mm)	ap max. (mm)	ae max. (mm)	fz (mm/tooth)
2	< 2.0	2	0.010 - 0.030
3	< 3.0	3	0.015 - 0.040
4	< 4.0	4	0.025 - 0.050
5	< 5.0	5	0.035 - 0.060
6	< 6.0	6	0.045 - 0.080
8	< 8.0	8	0.055 - 0.100
10	< 10.0	10	0.075 - 0.120
12	< 12.0	12	0.090 - 0.140

FBK0503944

Workpiece material: Graphite

	Competitor	Totem
Ø	6 mm	6 mm
Z	3 Flutes	3 Flutes
vc	547 m/min	547 m/min
n	29000 rpm	29000 rpm
Fz	0.005 mm/t	0.023 mm/t
vf	580 mm/min	2000 mm/min
ap	3 mm	3 mm
ae	0.5 mm	0.5 mm
Coolant	air	air

Q	0.87 cm ³ /min	3.00 cm ³ /min
Toollife	2 h 37 min	7 h 14 min

Higher tool life

FBK0504691

Workpiece material: EDM-3 Graphite

	Totem
Ø	4 mm
Z	3 Flutes
vc	440 m/min
n	35000 rpm
Fz	0.049 mm/t
vf	5145 mm/min
ap	0.8 mm
ae	1.6 mm
Coolant	air

Q	6.60 cm ³ /min
---	---------------------------

Higher MRR

Optimum Flutes

Centre cutting high performance ball nose for graphite

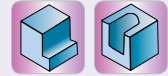

END MILLS

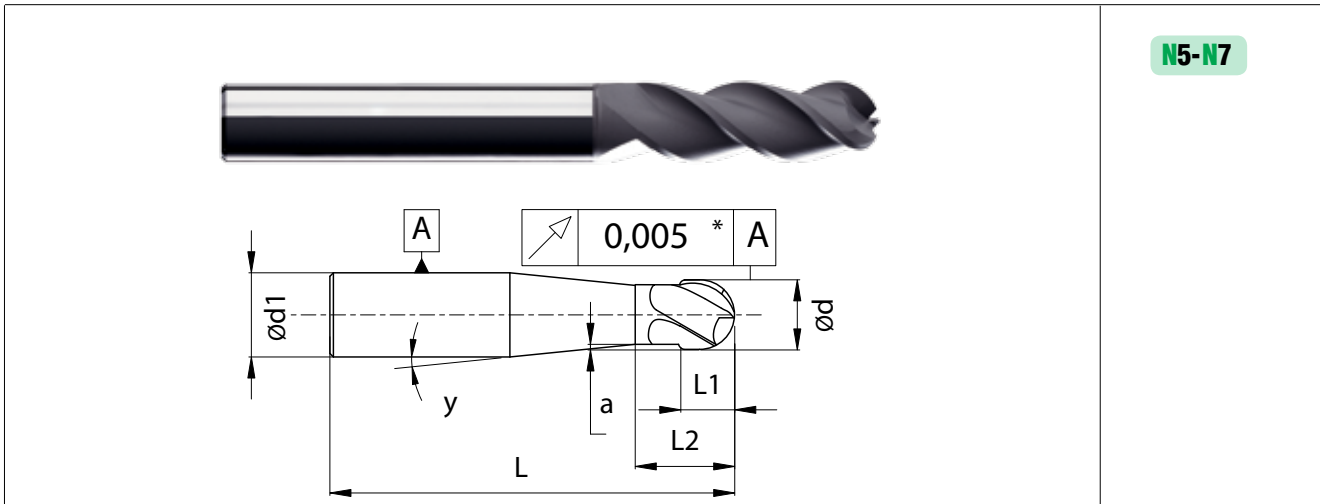

N5-N7

Unit : mm

Ød (mm)	r (mm)	Ød1 (mm)	L (mm)	L1 (mm)	L2 (mm)	a (mm)	z	γ (°)	EDP No
Short									
2	1	3	50	3	10	0.1	2	15	FBK0504272
3	1.5	6	51	4	10	0.1	2	15	FBK0504273
4	2	6	51	4	10	0.1	4	15	FBK0504274
5	2.5	6	51	5	10	0.15	4	15	FBK0504275
6	3	6	51	6	10	0.2	4	-	FBK0504276
8	4	8	64	8	15	0.3	4	-	FBK0504277
10	5	10	78	10	20	0.3	4	-	FBK0504278
12	6	12	78	10	20	0.3	4	-	FBK0504279
Standard									
2	1	2	50	10	-	-	3	-	FBK0504280
2	1	3	50	10	-	-	3	15	FBK0504281
2	1	3	50	10	15	0.1	3	15	FBK0506037
2	1	3	50	10	20	0.1	3	15	FBK0506038
2	1	3	65	10	30	0.1	3	15	FBK0506039
3	1.5	3	50	10	-	-	3	-	FBK0504282
3	1.5	3	50	10	15	0.1	3	-	FBK0506037
3	1.5	3	50	10	20	0.1	3	-	FBK0506038



Solid Carbide End Mills

Proton HD Series

Optimum
Flutes

Centre cutting high performance
ball nose for graphite



END MILLS

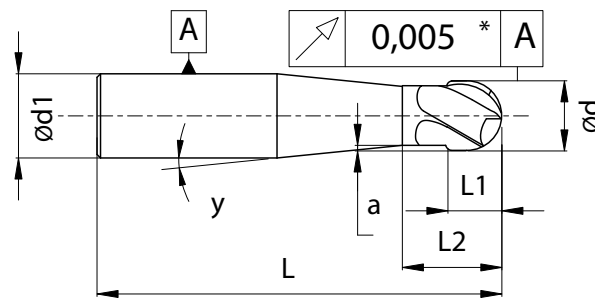

N5-N7

Unit : mm

Ød (mm)	r (mm)	Ød1 (mm)	L (mm)	L1 (mm)	L2 (mm)	a (mm)	z	γ (°)	EDP No
3	1.5	3	50	10	30	0.1	3	-	FBK0506039
4	2	4	60	15	-	-	3	-	FBK0504283
5	2.5	5	60	20	-	-	3	-	FBK0504284
6	3	6	78	30	-	-	3	-	FBK0504285
8	4	8	78	30	-	-	3	-	FBK0504286
10	5	10	78	30	-	-	3	-	FBK0504287
12	6	12	89	30	-	-	3	-	FBK0504288
Long									
2	1	3	102	6	-	-	2	15	FBK0504289
3	1.5	3	102	16	-	-	2	-	FBK0504290
4	2	4	102	16	-	-	2	-	FBK0504291
6	3	6	102	42	-	-	2	-	FBK0504292
6	3	6	150	42	-	-	2	-	FBK0504293
8	4	8	102	42	-	-	2	-	FBK0504294
8	4	8	150	42	-	-	2	-	FBK0504295
10	5	10	150	45	-	-	2	-	FBK0504296
12	6	12	150	65	-	-	2	-	FBK0504297



Solid Carbide End Mills

Cutting conditions

END MILLS

Centre cutting high performance ball nose for graphite

Material group	TSR	Hardness	Cutting speed	Coolant
	(N/mm ²)	HRc	Vc m/min	
N5			< 600	air
N6			< 600	air
N7			350 - 500	air

Advantages

- More accuracy
- Smooth surface on the workpiece
- Better tool life

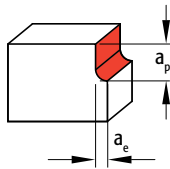

Roughing

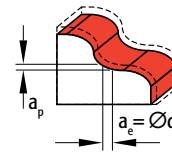

Finishing

Ød (mm)	ap max. (mm)	ae max. (mm)	fz (mm/tooth)
2	< 4.0	< 0.4	0.012 - 0.036
3	< 6.0	< 0.6	0.018 - 0.048
4	< 8.0	< 0.8	0.030 - 0.060
5	< 10.0	< 1.0	0.042 - 0.072
6	< 12.0	< 1.2	0.054 - 0.096
8	< 16.0	< 1.6	0.066 - 0.120
10	< 20.0	< 2.0	0.090 - 0.144
12	< 24.0	< 2.4	0.108 - 0.168

Ød (mm)	ap max. (mm)	ae max. (mm)	fz (mm/tooth)
< 0.4	0.2	0.012 - 0.036	0.007 - 0.015
< 0.6	0.3	0.018 - 0.048	0.010 - 0.020
< 0.8	0.4	0.030 - 0.060	0.012 - 0.021
< 1.0	0.5	0.042 - 0.072	0.014 - 0.023
< 1.2	0.6	0.054 - 0.096	0.015 - 0.025
< 1.6	0.8	0.066 - 0.120	0.020 - 0.030
< 2.0	1	0.090 - 0.144	0.025 - 0.035
< 2.4	1.2	0.108 - 0.168	0.028 - 0.040

FBK0504283

Workpiece material: ISO 63

	Totem
Ø	4mm
Z	3 Flutes
vc	276 m/min
n	22000 rpm
Fz	0.121 mm/t
vf	8000 mm/min
ap	5.0 mm
ae	0.1 mm
Coolant	air

Q	4.0 cm ³ /min
---	--------------------------

Higher productivity



2 Flute

Centre cutting high performance micro end mill with corner radius for graphite



END MILLS

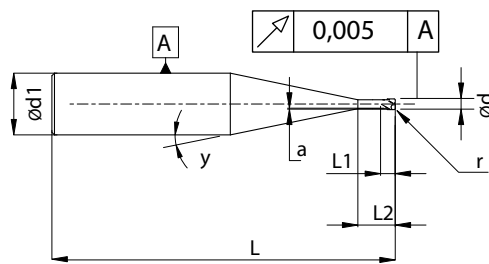

N5-N7

Unit : mm

Ød (mm)	r (mm)	Ød1 (mm)	L (mm)	L1 (mm)	L2 (mm)	a (mm)	z	y (°)	Effective length compared with Inclined Angle				EDP No
									0.5°	1.0°	2.0°	3.0°	
0.3	0.05	6	64	1	-	-	2	7	1.743	1.896	2.304	2.944	FBK0504298
0.3	0.05	6	64	1.5	2.5	0.01	2	7	2.908	3.148	3.771	4.710	FBK0504299
0.3	0.05	6	64	1.5	5	0.01	2	8	5.562	5.967	6.988	8.436	FBK0504300
0.4	0.05	6	64	1.5	-	-	2	6	1.744	1.900	2.319	2.985	FBK0504301
0.4	0.05	6	64	1.5	2.5	0.01	2	7	2.912	3.156	3.797	4.773	FBK0504302
0.4	0.05	6	64	1.5	5	0.01	2	8	5.568	5.982	7.029	8.529	FBK0504303
0.5	0.05	6	64	1.5	-	-	2	6	2.286	2.492	3.043	3.918	FBK0504304
0.5	0.05	6	64	1.5	3.5	0.01	2	7	3.984	4.310	5.158	6.429	FBK0504305
0.5	0.05	6	64	1.5	7	0.01	2	8	7.671	8.192	9.480	11.256	FBK0504306
0.5	0.05	6	64	1.5	10	0.01	2	10	10.772	11.375	12.813	14.671	FBK0504307
0.6	0.05	6	64	1.5	-	-	2	6	2.890	3.157	3.878	5.036	FBK0504308
0.6	0.05	6	64	2	3.5	0.025	2	7	4.185	4.534	5.442	6.815	FBK0504309
0.6	0.05	6	64	2	7	0.025	2	8	7.864	8.405	9.750	11.614	FBK0504310
0.6	0.05	6	64	2	10	0.025	2	10	10.959	11.582	13.070	15.001	FBK0504311
0.8	0.05	6	64	2	-	-	2	6	3.435	3.760	4.642	6.078	FBK0504312
0.8	0.05	6	64	2	5	0.025	2	7	5.787	6.253	7.456	9.240	FBK0504313
0.8	0.05	6	64	2	7.5	0.025	2	8	8.402	8.987	10.447	12.478	FBK0504314
0.8	0.05	6	64	2	10	0.025	2	9	10.978	11.629	13.195	15.253	FBK0504315
0.8	0.05	6	64	2	15	0.025	2	13	16.043	16.674	18.099	19.794	FBK0504316
1	0.05	6	64	2.5	-	-	2	6	3.982	4.368	5.423	7.163	FBK0504317
1	0.05	6	64	3	5	0.025	2	7	5.805	6.294	7.572	9.512	FBK0504318
1	0.05	6	64	3	7.5	0.025	2	8	8.422	9.036	10.581	12.772	FBK0504319
1	0.05	6	64	3	10	0.025	2	9	10.999	11.680	13.333	15.537	FBK0504320
1	0.05	6	64	3	15	0.025	2	13	16.057	16.716	18.212	20.005	FBK0504321
1	0.05	6	64	3	20	0.025	2	18	21.124	21.741	23.091	24.621	FBK0504322
1.2	0.05	6	64	3	5	0.025	2	7	5.950	6.475	7.869	10.037	FBK0504323
1.2	0.05	6	64	3	10	0.025	2	9	11.183	11.907	13.683	16.087	FBK0504324
1.5	0.05	6	64	3	5	0.025	2	6	5.978	6.548	8.094	10.609	FBK0504325
1.5	0.05	6	64	3	7.5	0.025	2	7	8.618	9.326	11.166	13.921	FBK0504326
1.5	0.05	6	64	3	10	0.025	2	8	11.215	11.996	13.941	16.647	FBK0504327
1.5	0.05	6	64	3	15	0.025	2	12	16.319	17.069	18.798	20.921	FBK0504328
1.5	0.05	6	64	3	20	0.025	2	15	21.448	22.194	23.854	25.785	FBK0504329



Solid Carbide End Mills

Cutting conditions

Center cutting high performance micro end mill with corner radius for graphite

Material group	TSR	Hardness	Cutting speed	Coolant
	(N/mm ²)	HRc	Vc m/min	
N5			< 600	air
N6			< 600	air
N7			350 - 500	air

Advantages

- Excellent accuracy and tolerances
- Optimized surface finish on workpiece
- Leading diamond coating technology
- Superior tool life

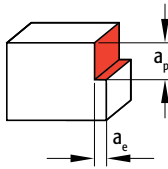

Shoulder milling

Ød (mm)	ap max. (mm)	ae max. (mm)	fz (mm/tooth)
0.3	< 0.6	< 0.03	0.007 - 0.014
0.4	< 0.8	< 0.04	0.010 - 0.018
0.5	< 1.0	< 0.05	0.012 - 0.024
0.6	< 1.2	< 0.06	0.014 - 0.026
0.8	< 1.6	< 0.08	0.018 - 0.030
1	< 2.0	< 0.10	0.022 - 0.036
1.2	< 2.4	< 0.12	0.024 - 0.042
1.5	< 3.0	< 0.15	0.030 - 0.048

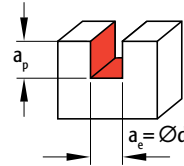

Slot milling

Ød (mm)	ap max. (mm)	ae max. (mm)	fz (mm/tooth)
0.3	< 0.15	0.3	0.006 - 0.012
0.4	< 0.20	0.4	0.008 - 0.015
0.5	< 0.25	0.5	0.010 - 0.020
0.6	< 0.30	0.6	0.012 - 0.022
0.8	< 0.40	0.8	0.015 - 0.025
1	< 0.50	1	0.018 - 0.030
1.2	< 0.60	1.2	0.020 - 0.035
1.5	< 0.75	1.5	0.025 - 0.040

Cutting speed Vc is based on max. 40,000 rpm.

Given conditions are based on micro short length endmills; when using endmills with longer L2-length, reduce fz according table.

L2-Length	Reduction
1-5 x d	0%
5-10 x d	30%
10 ~	50%

2 Flute

Centre cutting high performance micro ball nose for graphite



END MILLS

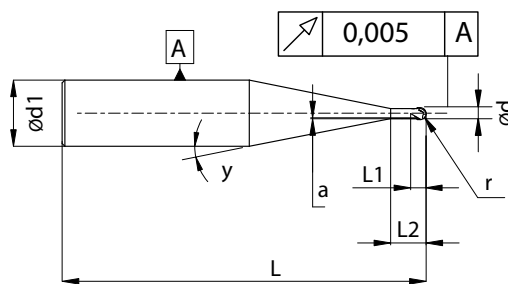

N5-N7

Unit : mm

Ød (mm)	r (mm)	Ød1 (mm)	L (mm)	L1 (mm)	L2 (mm)	a (mm)	z	γ (°)	Effective length compared with Inclined Angle				EDP No
									0.5°	1.0°	2.0°	3.0°	
0.3	0.15	6	64	1	-	-	2	6	1.736	1.886	2.292	2.946	FBK0504330
0.3	0.15	6	64	1.5	2.5	0.01	2	7	2.901	3.131	3.731	4.635	FBK0504331
0.3	0.15	6	64	1.5	5	0.01	2	8	5.555	5.953	6.953	8.373	FBK0504332
0.4	0.2	6	64	1.5	-	-	2	6	1.731	1.880	2.283	2.942	FBK0504333
0.4	0.2	6	64	1.5	2.5	0.01	2	7	2.900	3.131	3.735	4.656	FBK0504334
0.4	0.2	6	64	1.5	5	0.01	2	8	5.557	5.959	6.976	8.432	FBK0504335
0.5	0.25	6	64	1.5	-	-	2	6	2.272	2.472	3.020	3.928	FBK0504336
0.5	0.25	6	64	1.5	3.5	0.01	2	7	3.968	4.277	5.078	6.28	FBK0504337
0.5	0.25	6	64	1.5	7	0.01	2	8	7.658	8.164	9.417	11.143	FBK0504338
0.5	0.25	6	64	1.5	10	0.01	2	10	10.761	11.353	12.762	14.584	FBK0504339
0.6	0.3	6	64	1.5	-	-	2	6	2.871	3.131	3.849	5.055	FBK0504340
0.6	0.3	6	64	2	3.5	0.025	2	7	4.166	4.492	5.341	6.624	FBK0504341
0.6	0.3	6	64	2	7	0.025	2	8	7.848	8.371	9.670	11.47	FBK0504342
0.6	0.3	6	64	2	10	0.025	2	10	10.946	11.554	13.006	14.89	FBK0504343
0.8	0.4	6	64	2	-	-	2	6	3.413	3.731	4.625	6.177	FBK0504344
0.8	0.4	6	64	2	5	0.025	2	7	5.761	6.196	7.320	8.987	FBK0504345
0.8	0.40	6	64	2	7.5	0.025	2	8	8.379	8.938	10.332	12.273	FBK0504346
0.8	0.40	6	64	2	10	0.025	2	9	10.958	11.587	13.100	15.089	FBK0504347
0.8	0.40	6	64	2	15	0.025	2	13	16.029	16.646	18.039	19.695	FBK0504348
1.0	0.50	6	64	2.5	-	-	2	5	3.958	4.341	5.437	7.410	FBK0504349
1.0	0.50	6	64	3	5	0.025	2	7	5.770	6.218	7.388	9.164	FBK0504350
1.0	0.50	6	64	3	7.5	0.025	2	8	8.392	8.970	10.427	12.491	FBK0504351
1.0	0.50	6	64	3	10	0.025	2	9	10.973	11.624	13.205	15.313	FBK0504352
1.0	0.50	6	64	3	15	0.025	2	13	16.040	16.679	18.131	19.872	FBK0504353
1.0	0.50	6	64	3	20	0.025	2	18	21.111	21.715	23.035	24.532	FBK0504354
1.2	0.60	6	64	3	5	0.025	2	7	5.905	6.378	7.630	9.579	FBK0504355
1.2	0.60	6	64	3	10	0.025	2	9	11.149	11.836	13.518	15.796	FBK0504356
1.5	0.75	6	64	3	5	0.025	2	6	5.917	6.413	7.761	9.953	FBK0504357
1.5	0.75	6	64	3	7.5	0.025	2	7	8.564	9.210	10.889	13.401	FBK0504358
1.5	0.75	6	64	3	10	0.025	2	8	11.169	11.898	13.713	16.238	FBK0504359
1.5	0.75	6	64	3	15	0.025	2	12	16.288	17.004	18.656	20.684	FBK0504360
1.5	0.75	6	64	3	20	0.025	2	15	21.425	22.145	23.749	25.615	FBK0504361

Cutting conditions

Center cutting high performance micro end mill for graphite

Material group	TSR	Hardness	Cutting speed	Coolant
	(N/mm ²)	HRc	Vc m/min	
N5			< 600	air
N6			< 600	air
N7			350 - 500	air

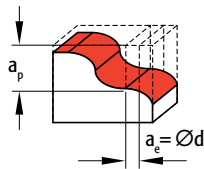
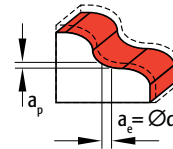
Shoulder milling

Slot milling

Ød (mm)	ap max. (mm)	ae max. (mm)	fz (mm/tooth)
0.3	< 0.3	<0.03	0.007 - 0.014
0.4	< 0.4	<0.04	0.010 - 0.018
0.5	< 0.5	<0.05	0.012 - 0.024
0.6	< 0.6	<0.06	0.014 - 0.026
0.8	< 0.8	<0.08	0.018 - 0.030
1	< 1.0	<0.10	0.022 - 0.036
1.2	< 1.2	<0.12	0.024 - 0.042
1.5	< 1.5	<0.15	0.030 - 0.048

Ød (mm)	ap max. (mm)	ae max. (mm)	fz (mm/tooth)
0.3	< 0.03	0.03	0.007 - 0.014
0.4	< 0.04	0.04	0.010 - 0.018
0.5	< 0.05	0.05	0.012 - 0.024
0.6	< 0.06	0.06	0.014 - 0.026
0.8	< 0.08	0.08	0.018 - 0.030
1	< 0.10	0.1	0.022 - 0.036
1.2	< 0.12	0.12	0.024 - 0.042
1.5	< 0.15	0.15	0.030 - 0.048

FBK0504349
Workpiece material: Poco Graphite

Hardness: 1700

	Competiton	Totem
Ø	1mm	1mm
Z	2 Flutes	2 Flutes
vc	126 m/min	126 m/min
n	40000 rpm	40000 rpm
Fz	0.010 mm/t	0.013 mm/t
vf	800 mm/min	1000 mm/min
ap	0.05 mm	0.05 mm
ae	0.10 mm	0.10 mm
Coolant	air	air

Q	4.0 mm ³ /min	5.0 mm ³ /min
---	--------------------------	--------------------------

Excellent surface finish

Cutting speed Vc is based on max. 40,000 rpm.
 Given conditions are based on micro short length endmills;
 when using endmills with longer L2-length, reduce fz
 according table.

L2-Length	Reduction
1-5 x d	0%
5-10 x d	30%
10 ~	50%



Proton Plus (45-60 HRc)



Features

- Superior nano grain structure raw material
- Wear resistant grade
- Ideal chip flow geometry
- Close tolerance end mills for finishing for higher accuracy

Functions

- Operates at high cutting speeds on hardened materials
- Polishing for hardened dies can be minimized
- No need of multiple setups, Job can be finished with single setup with high accuracy

Benefits

- Higher Tool Life and consistency

FBK0504268

Workpiece material: ISO 63

	Competitor	Totem
∅	6mm	6mm
Z	2 Flutes	2 Flutes
Vc	226 m/min	226 m/min
n	12000 rpm	1200 rpm
Fz	0.08 mm/tooth	0.08 mm/tooth
Vf	2000mm/min	2000mm/min
ap	0.15mm	0.15mm
ae	0.15mm	0.15mm
Coolant	Air	Air
Q	45mm3/min	45mm3/min
Tool Life	13 Hrs	21 Hrs

Higher productivity